

# **HOOVER®**

## **Bagged Tempo™**

### **Upright Vacuum Cleaner**

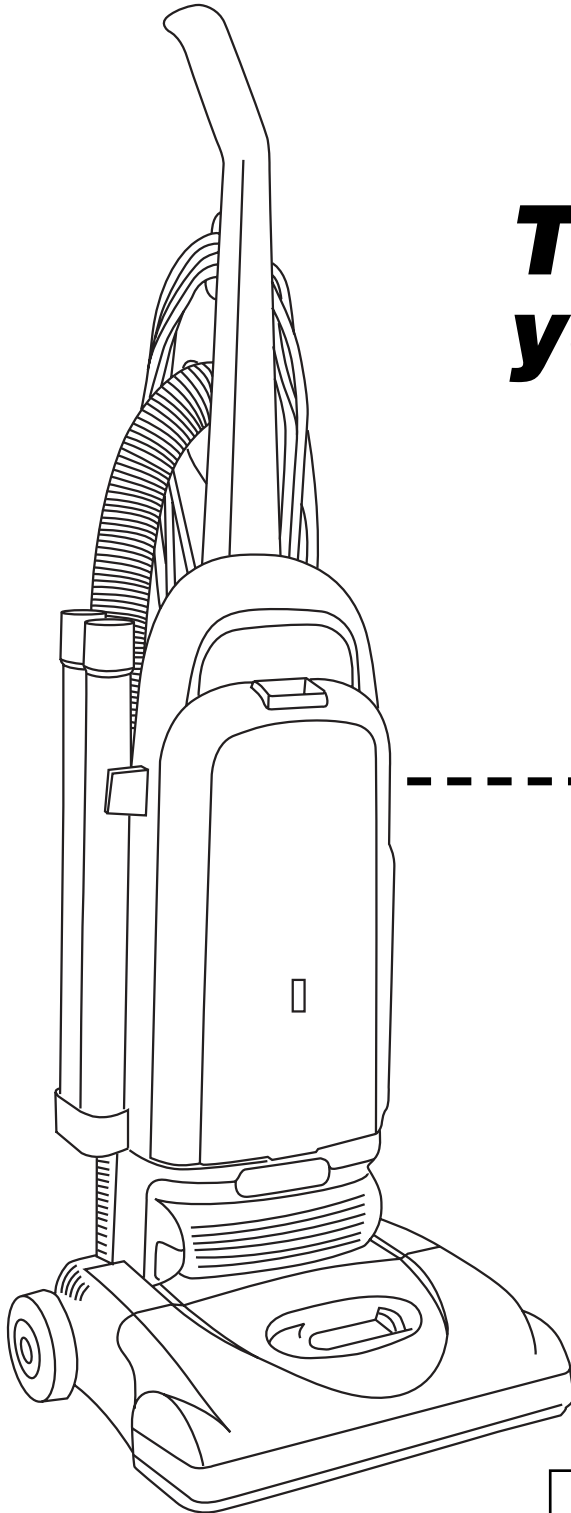

***Thank you for  
your purchase!***

**Owner's Manual**

**ENGLISH → pp. 1-12**

ESPAÑOL → pág. 13-20

FRANÇAIS → pág. 21-28



This product was designed for  
easy assembly (see page 3)

**Review this manual before  
operating cleaner**

# Thank you for choosing a HOOVER product.

Please enter the COMPLETE model and serial numbers in the spaces provided. The numbers are located on the bottom of your cleaner.

Model \_\_\_\_\_

Serial number \_\_\_\_\_

Hint: Attach your sales receipt to this owner's manual. Verification of date of purchase may be required for warranty service of your HOOVER product.

Be sure to fill out and return the product registration card included with your cleaner.

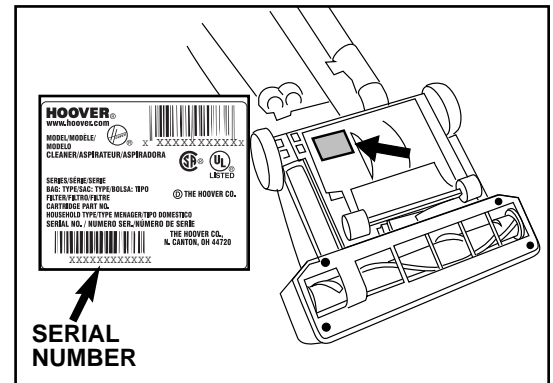

## Important Safeguards

When using an electrical appliance, always follow basic precautions, including the following:

**READ ALL INSTRUCTIONS BEFORE USING THIS APPLIANCE**

## Contents

Assembling Cleaner .....	3-4
How to use .....	5
Cleaner Description .....	5
Cleaning Tools.....	7-8
If You Have a Problem .....	12
Clearing Blockages .....	12
Important Safeguards .....	2
Maintenance	
Authorized Service.....	11
Cleaning Filters .....	9
Lubrication .....	11
Replacing Agitator Brush Roll .....	11
Replacing Belt .....	10-11
Replacing Headlight.....	10
Replacing Filter Bag .....	8-9
Thermal Protector .....	11
Warranty .....	12

## Warning:

To reduce the risk of fire, electric shock, or injury:

- Do not use outdoors or on wet surfaces.
- Close supervision is necessary when any appliance is used by or near children. Do not allow vacuum cleaner to be used as a toy or to run unattended at any time.
- Keep hair, loose clothing, fingers, feet and all parts of body away from openings, rotating agitator and other moving parts. Do not operate cleaner in bare feet or when wearing open toe shoes or sandals.
- Do not pick up anything that is burning or smoking, such as cigarettes, matches, or hot ashes.
- Do not use to pick up flammable or combustible materials such as gasoline or fine wood sandings or use in areas where they may be present.
- Avoid picking up hard, sharp objects with the cleaner. They may damage the cleaner and the bag.
- Always turn off this appliance before connecting or disconnecting hose.
- Do not use without dust bag or filters in place. Empty bag frequently when picking up very fine materials such as powder.
- Use extra care when cleaning on stairs.
- Do not put any object into openings. Do not use with any opening blocked; keep free of dust, lint, hair, or anything that may reduce air flow.
- Do not pull or carry by cord, use cord as a handle, close door on cord or pull cord around sharp edges or corners. Do not run appliance over cord. Keep cord away from heated surfaces.
- Always disconnect cord from electrical outlet before servicing the cleaner.
- Unplug cleaner when not in use. Turn off all controls before unplugging.
- Do not unplug by pulling on cord. To unplug, grasp the plug, not the cord. Never handle plug or appliance with wet hands.
- The use of an extension cord is not recommended.
- Do not use with damaged cord or plug. If appliance is not working as it should, has been dropped, damaged, left outdoors, or dropped into water, take it to a Hoover Factory Service Center or Authorized Hoover Warranty Service Dealer (Depot).
- Use vacuum cleaner only for its intended use as described in the instructions. Use only attachments recommended by The Hoover Company; others may cause hazards.



© 2003 The Hoover Company

www.hoover.com

# Save these instructions!

## If you need any assistance:

Visit our website at **www.hoover.com**. Click on the “Service” button to find the service outlet nearest you OR

Call **1-800-944-9200** for an automated referral of service outlet locations (U.S. only) OR

Call 1-330-499-9499 to speak with a representative in our Consumer Response Center.

**Please do not return this product to the store.**

# 1. Cleaner Assembly

## Carton contents

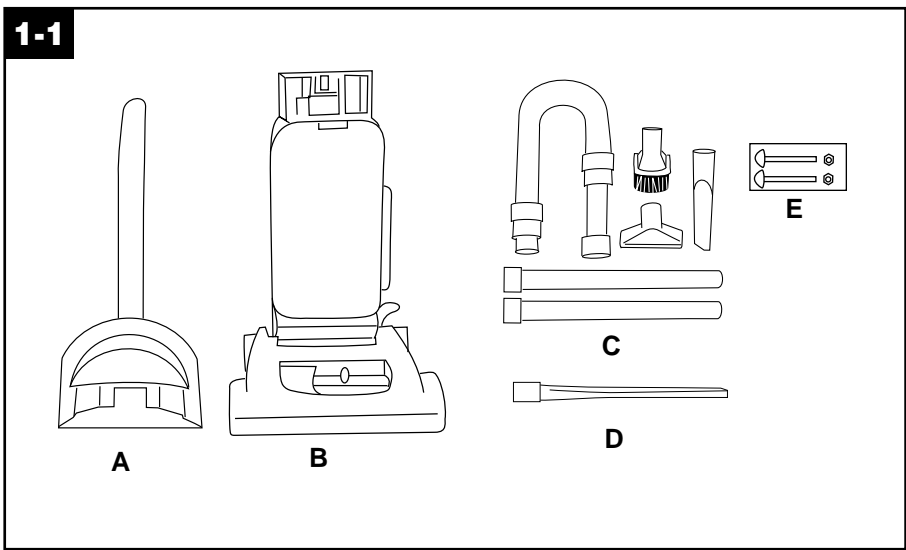

Empty carton. Find the parts shown before disposing of packing materials.

- A. Handle section**
- B. Cleaner body**
- C. Hose, cleaning tools and wands**
- D. Crevice wand** (included with some models)
- E. Handle bolts and nuts packet** (in bag with owner's manual)

## Attach handle

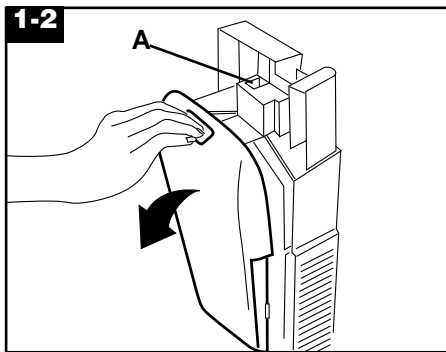

Remove bag door on cleaner body by pushing down at top of door and pulling door outward.

**Switch (A) above bag door should be in OFF position.**

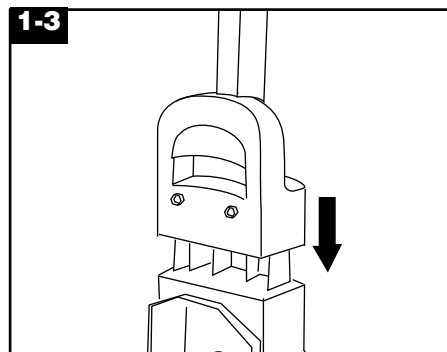

Slide handle onto cleaner body.

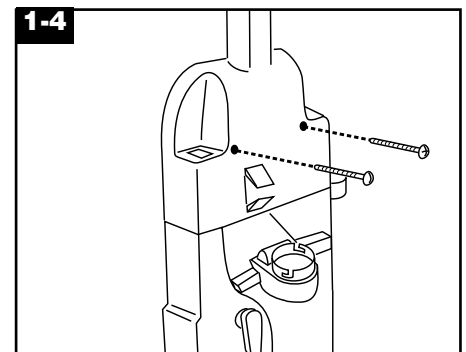

Push bolts into holes on back of handle.

**Continued →**

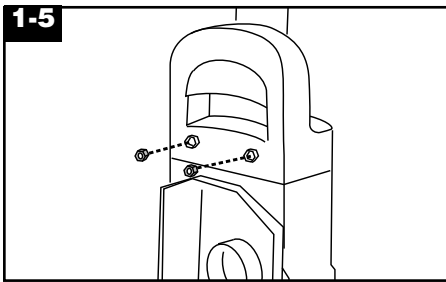

Place nuts in recessed areas on front of handle. Hold each nut in place while tightening each bolt securely with a Phillips screw driver.

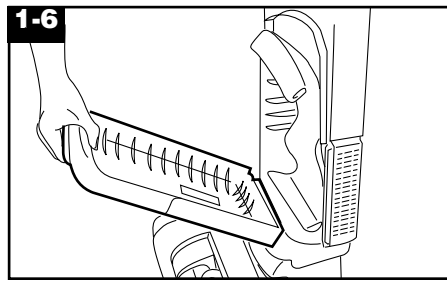

Reposition bag door by fitting tabs on bottom of door into opening. Press top of door to snap securely shut.

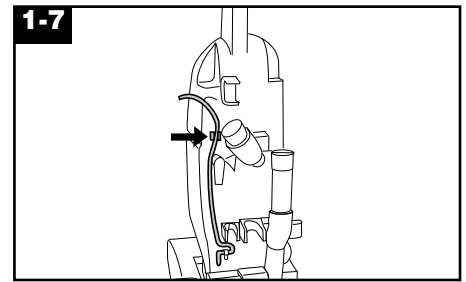

Position cord on back of cleaner as shown and press cord into clip.

## Attach hose

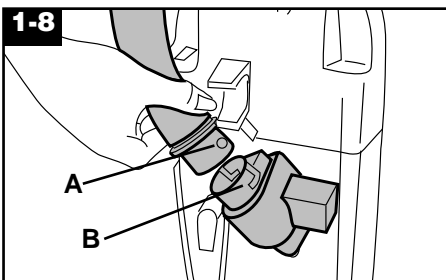

Align end of hose with projections (A) over slots (B) in dirt duct.

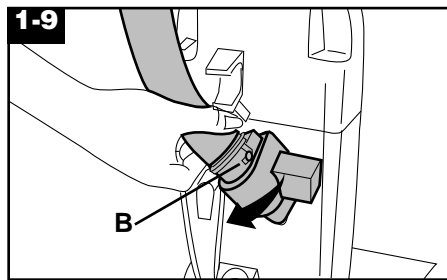

Slide hose into duct (B) and twist hose to lock it into place.

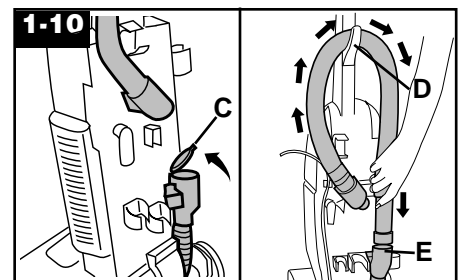

Lift hose tube cover (C). Position hose over hose hook (D) and into hose tube (E).

## Position tools

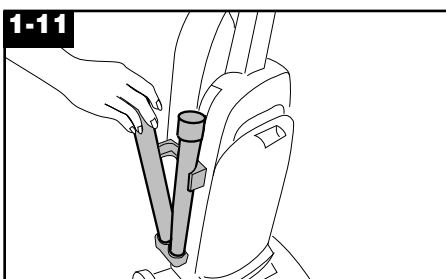

Place smaller unridged end of wand into bottom of rack. Snap wand into clip. Repeat with other wand.

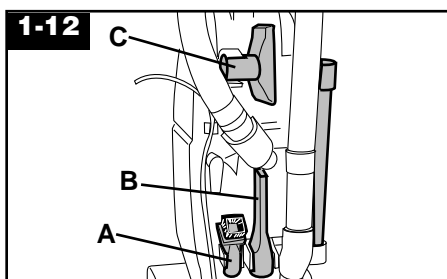

Snap ends of dusting brush (A), crevice tool (B) and furniture nozzle (C) into clips as shown.

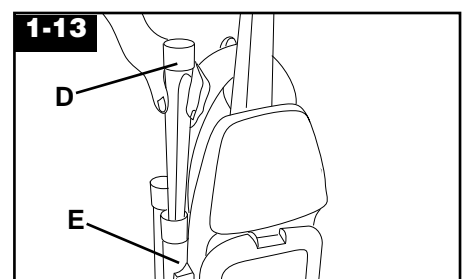

Place crevice wand (D) (available on some models) inside extension wand (E).

## 2. How to use

### Cleaner description

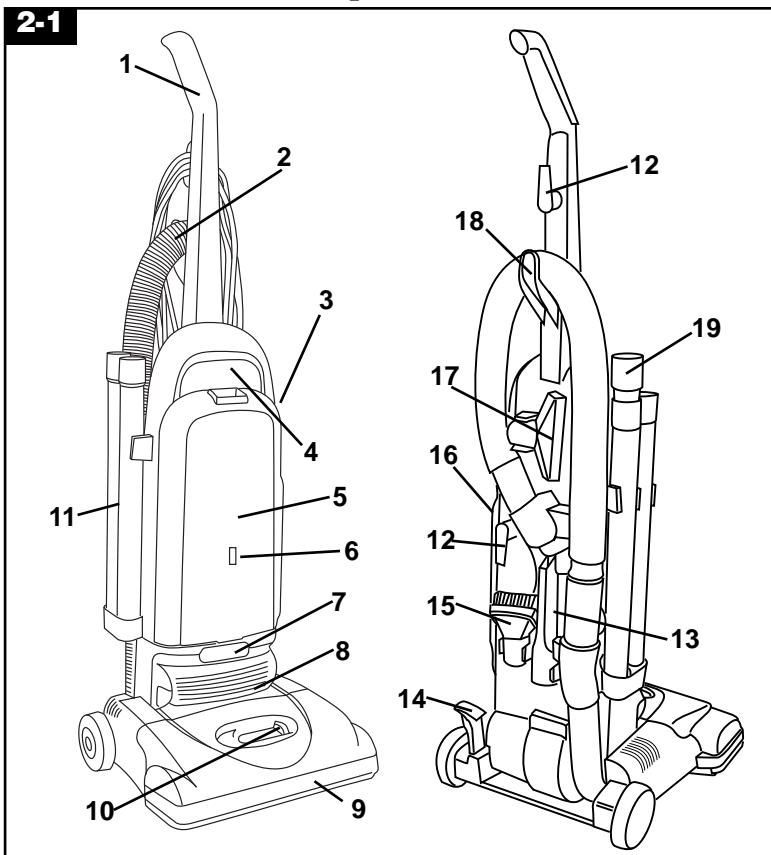

1. Handle
2. Hose
3. **ON/OFF switch:** located on left rear corner of cleaner body
4. Carrying handle
5. Bag door
6. Check bag indicator
7. Stair cleaning handle: located on lower edge of dirt cup.
8. Headlight
9. Furniture guard: helps prevent cleaner from marking furniture.
10. Nozzle control knob: slide knob to correct setting for height of carpet being cleaned.
11. Wands
12. Cord hooks: wrap cord around hooks for storage. The top hook rotates right or left for easy cord release.
13. Crevice tool
14. Handle release lever: step on lever to lower handle to operating or low positions.
15. Dusting brush
16. Final filter exhaust
17. Furniture nozzle
18. Hose hook
19. Crevice wand\*: stores inside of extension wand

\*Available on some models

**Operate cleaner only at voltage specified on data plate on bottom of cleaner.**  
This cleaner is intended for household use.

### Polarized plug

To reduce the risk of electric shock, this appliance has a polarized plug (one blade is wider than the other). This plug will fit in a polarized outlet only one way. If the plug does not fit fully in the outlet, reverse the plug. If it still does not fit, contact a qualified electrician to install the proper outlet. Do not change the plug in any way.

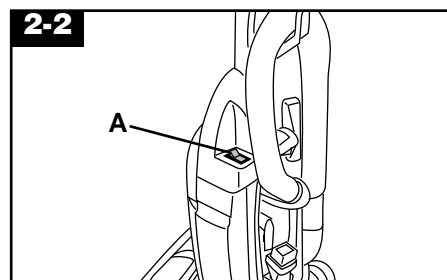

### ON-OFF switch

Plug cord into electrical outlet.

To turn cleaner ON, push switch (A) toward front of cleaner.

To turn cleaner OFF, push toward back of cleaner.

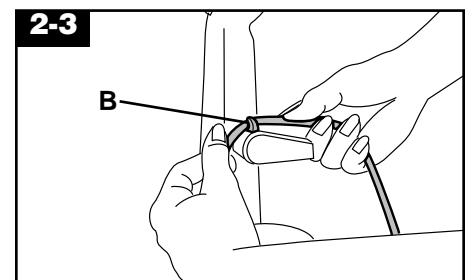

### Cord clip

To help keep the cord out of the way while vacuuming, position cord down into cord clip (B) located between top cord hook and handle.

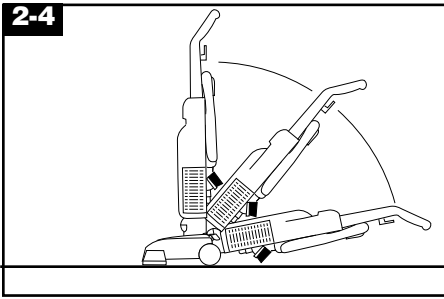

## Handle positions

The handle of your cleaner has three positions; **upright** for storage and when using cleaning tools; **operating position** for general operation on carpet and floors; **low** for reaching under low furniture. Step on handle release lever to lower handle.

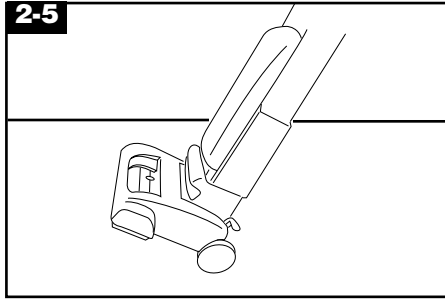

## Transporting cleaner

Put handle in upright position. Tilt cleaner back on rear wheels. Push forward.

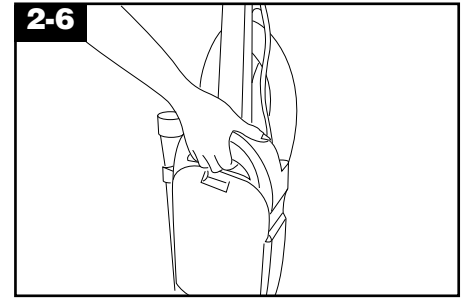

## Carrying handle

Use the carrying handle to lift the cleaner.

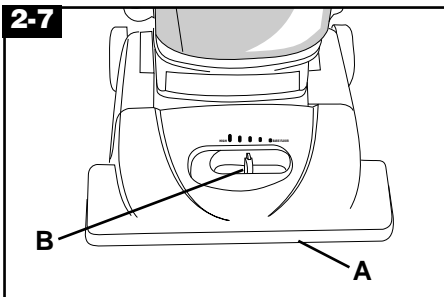

## Carpet height adjustment

The cleaning of carpet and rugs takes place at the nozzle (A).

When it is necessary to raise and lower the nozzle for various carpet pile heights, slide the nozzle control knob (B) to the desired setting.

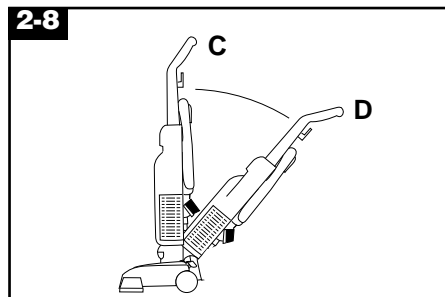

## Handle position

For ease in sliding knob, place handle in the upright position (C).

**The nozzle will not move into the adjusted position until the cleaner handle is lowered to the operating position (D).**

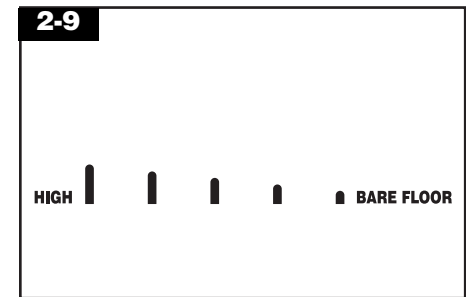

## Settings

**For maximum cleaning performance,** the following carpet height settings are recommended.

- **Lowest setting:** for all types of carpet and hard floors.

**Note:** If the cleaner is difficult to push, slide knob to the next higher setting.

- **Higher settings:** for very deep pile carpet where easier pushing effort is desired, while maintaining good cleaning performance.

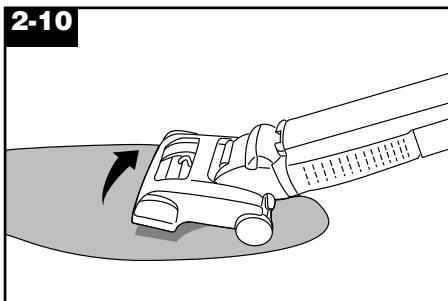

## Cleaning lightweight flexible rugs

Stand on one end of rug and move cleaner toward other end or edge. Before reaching edge, push down on handle. This will lift up the nozzle (front of cleaner) as shown and will prevent rug from clinging to cleaner. Continue to lift up nozzle so that when you have reached the edge, it is completely off the rug. Move cleaner back to start again, lower nozzle, and use only forward strokes.

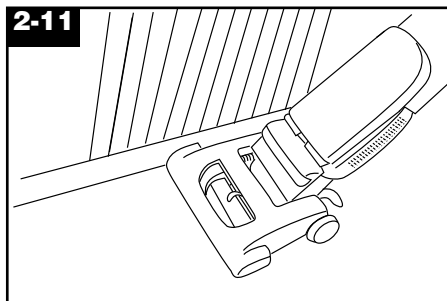

## Edge cleaning

Edge cleaning is provided on both sides of the nozzle to remove dirt in carpet near baseboards and furniture.

Guide either side of nozzle parallel to edge of carpet or furniture.

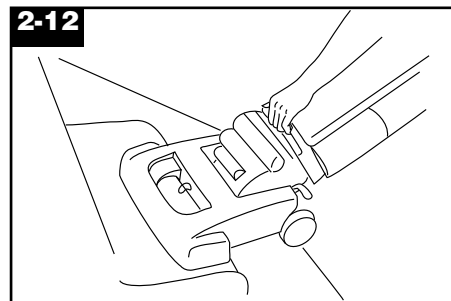

## Stair cleaning

A stair cleaning handle has been designed for ease in using your cleaner on stairs. With handle in operating position, place fingers under edge of stair cleaning handle and guide cleaner with other hand on upper handle.

As an alternative, you may use the hose and furniture nozzle for stair cleaning. Clean from bottom to top.

**When using cleaning tools, the agitator will continue to rotate.**

**CAUTION: To avoid personal injury or unnecessary wear to carpet, and to prevent the cleaner from falling, always place it at the bottom of the stairs.**

## Cleaning tools

Tools allow for cleaning surfaces above the floor and for reaching hard to clean areas.

The cleaner is ready for tool use when handle is in upright position.

**CAUTION: Agitator continues to rotate while cleaner handle is in upright position. Avoid tipping cleaner or setting it on furniture, fringed area rugs or carpeted stairs during tool use.**

## How to clean tools

To clean the hose, wipe off dirt with a cloth dampened in a mild detergent. Rinse with a damp cloth.

Cleaning tools may be washed in warm water with a detergent. Rinse and air dry before using.

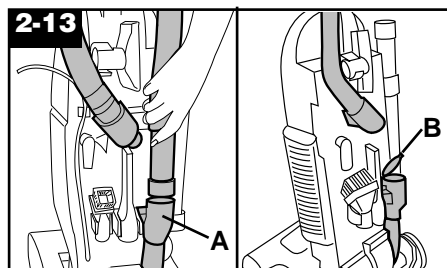

## Remove hose

When using cleaning tools, **cleaner handle should be in the upright position**. Also, **turn cleaner OFF before disconnecting and connecting hose to hose tube (A)**.

To use hose, lift hose end as shown.

Lower cover (B) onto hose tube. When you are finished cleaning with the tools, **be sure to lift cover from hose tube and reposition hose end into tube**.

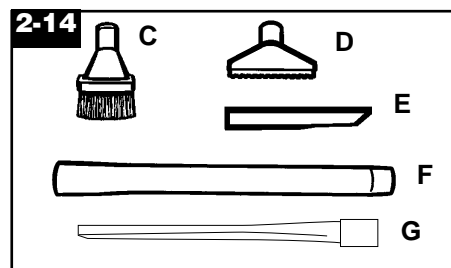

## Select proper tool

**C. Dusting brush** may be used for carved furniture, table tops, books, lamps, lighting fixtures, venetian blinds, baseboards, shutters, and registers.

**D. Furniture nozzle** may be used for upholstered furniture, draperies, mattresses, clothing, automobile interiors, and carpeted stairs.

**E. Crevice tool** may be used in tight spaces, corners and along edges in such places as dresser drawers, upholstered furniture, stairs and baseboards.

**F. Extension wands** are used to give extra length to your hose. Use it with any of the above tools.

**G. Crevice wand (included on some models)** may be used for the same tasks as the crevice tool is used. It can also be used for extra reach with the dusting brush and/or extension wand.

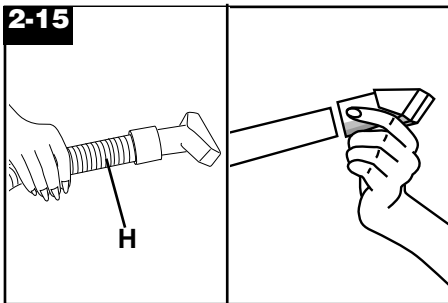

### Attach wand and tools

Attach tool or wand or crevice wand (some models) to the hose (H) by pushing it firmly into hose.

Attach second wand or tool to the wand in the same manner.

Twist wand or tool slightly to tighten or loosen the connection.

### Extra reach hose

(available at additional cost)

The extra reach hose provides you with a 20 foot reach to allow easier cleaning of stairs and hard to reach places. Follow the steps below for attaching and detaching hose.

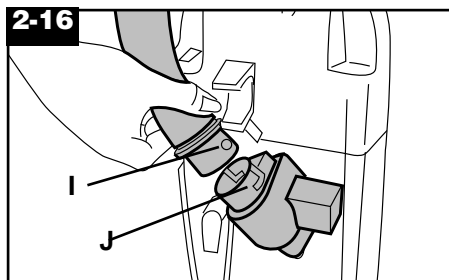

### Push ON/OFF switch to OFF position and unplug from electrical outlet.

Remove regular hose from cleaner.

Align end of extra reach hose with projections (I) over slots (J) in dirt duct.

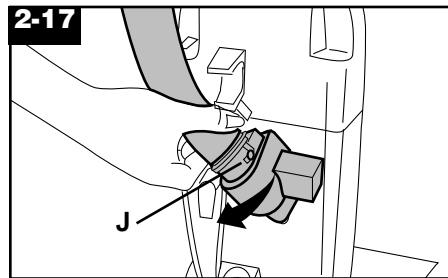

Slide hose into slots (J) and twist hose to lock it into place.

To detach hose, reverse procedure.

Attach wands or tools to the other end of hose.

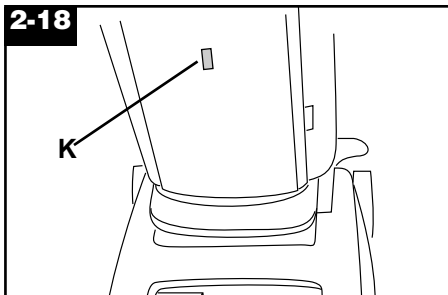

### Check bag indicator

The indicator (K), will begin to show red as the filter bag fills with dirt.

There are three conditions that will cause the indicator to become completely red:

1. The bag is full; change the bag.
2. Very fine materials have been picked up, clogging the bag pores; change the bag.
3. There is a blockage in the nozzle, hose, tools or at the bag opening; remove the blockage (see "Clearing blockages" section).

## 3. Maintenance

Familiarize yourself with these home maintenance tasks as proper use and care of your cleaner will ensure continued cleaning effectiveness.

### Filter bag When to replace

Check filter bag from time to time. It is recommended that you change the filter bag when dirt reaches the dotted line. If more dirt than this accumulates, your cleaner will not operate effectively.

NOTE: All new carpet has loose fibers which can fill the bag quickly while vacuuming. So, if you are using the cleaner on new carpet, be sure to change the filter bag often.

**CAUTION: Very fine materials, such as face powder or cornstarch, may seal the filter bag and may cause it to burst even though it is partially full of dirt. When the cleaner is used to remove material of this nature, change filter bag often.**

### Where to buy

Filter bags may be purchased from your Authorized Hoover Dealer (Depot), leading retailers, Hoover Factory Service Centers or through The Hoover Company on-line at [www.hoover.com](http://www.hoover.com).

### What to buy

To assure cleaning effectiveness, use only Genuine Hoover® Allergen Filtration Type Y disposable filter bags.



It is imperative that you use only genuine HOOVER filter bags made by The Hoover Company to assure that your cleaner operates at peak performance. HOOVER bags can be identified by these trademarks --



### Changing filter bag

Disconnect cleaner from electrical outlet.

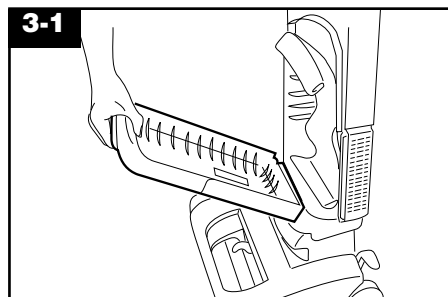

### Removing bag door

To change filter bag, push down at top of bag door and pull door forward.

Remove door.

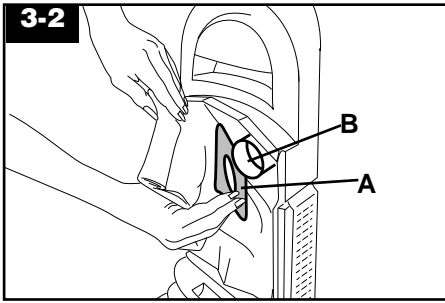

### Removing and installing filter bag

Grasp filter bag collar (A) and pull collar from tube (B).

Note: Do not clean out old filter bag and reuse. Discard used filter bag.

Hold new filter bag as shown. Align opening in filter bag with (B).

Push (A) firmly onto (B).

Tuck in filter bag.

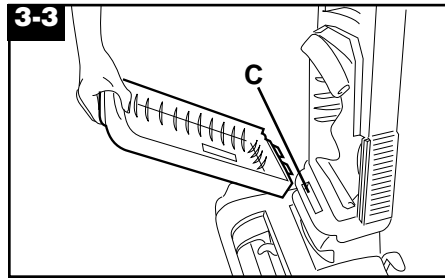

### Replacing bag door

Reposition bag door by placing tabs on bottom of door into opening (C).

Press top of door to snap securely shut.

## Secondary and final filters

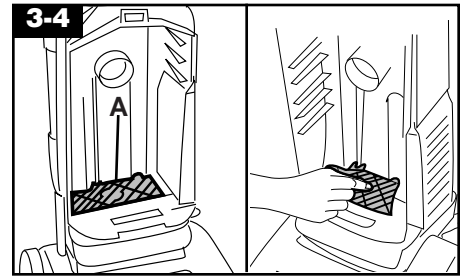

### Cleaning secondary filter

Disconnect cleaner from electrical outlet.

The **secondary filter (A)**, located behind the grill in the bottom of bag compartment, protects the motor from dirt particles.

If filter becomes dirty, pull off grill and lift out filter.

Hand wash filter in cold water with mild detergent, then air dry.

Reposition dry filter and grill.

Should you want to replace this filter, ask for **HOOVER part No. 38765019**.

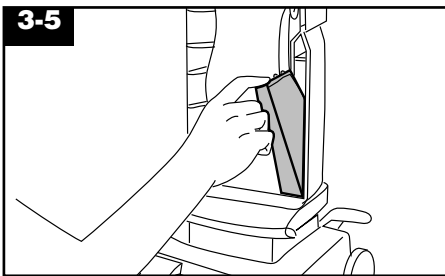

### Cleaning final filter

The **final filter** assists in returning clean air to the room.

To remove this filter when it becomes dirty, remove bag door and pull down top of filter.

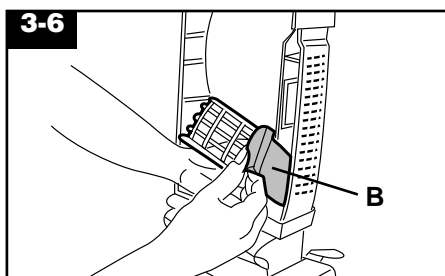

### Removing and replacing filter

Lift out filter (B) and hand wash it in cold water with mild detergent.

Let filter air dry and reposition it on the side of cleaner.

Reposition bag door.

Should you want to replace this filter, ask for **HOOVER part No. 40110004**.

**Do not operate cleaner without either the secondary or final filter in place.**

### Check agitator shield

Because your cleaner picks up so well, we strongly recommend you check for debris accumulation under the agitator shield each time you clean the filters.

Removing debris under the shield will help maintain your cleaner's excellent pick up and suction. Remove debris as follows:

1. Disconnect cleaner from electrical outlet.
2. Check for dirt accumulation by removing bottom plate (Fig. 3-10), removing agitator (Fig. 3-11), and lifting agitator shield (Fig. 3-13).
3. Remove any debris and replace shield, agitator and bottom plate (Figs. 3-13 to 3-15).

## Headlight replacement

### What to buy

This cleaner uses a 12 volt, wedge base type 912 bulb, **HOOVER part No. 27313101**.

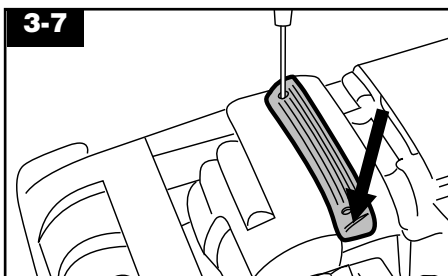

**Remove lens - Disconnect cleaner from electrical outlet.**

Using a screwdriver, remove the two screws as shown and lift off lens.

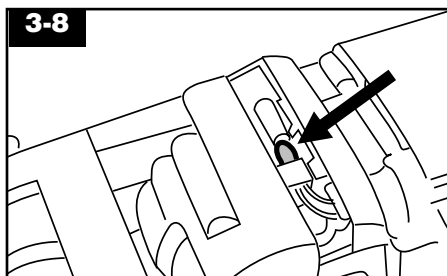

**Install bulb -** Pull old bulb straight out of socket. Push new bulb straight into socket until locked in place.

**Excessive force is not required.**

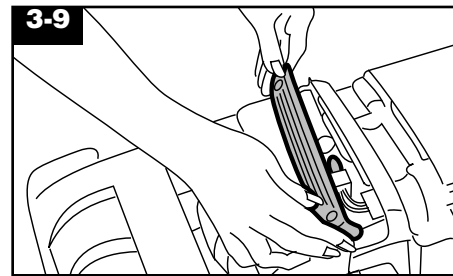

**Replace lens -** Reposition lens and secure with the two screws.

## Belt replacement

The belt on your Hoover cleaner causes the agitator to rotate and is important for the effective operation of the cleaner. The belt is located under the bottom plate of the cleaner and should be checked from time to time to be sure it is in good condition.

### When to replace

**Disconnect cleaner from electrical outlet.**

To check belt, remove bottom plate as shown in "How to replace". Replace belt if it is stretched, cut or broken.

### What to buy

To assure effective operation, use only genuine HOOVER belts with your cleaner. When purchasing a new belt, ask for **HOOVER part No. 38528033** (belt package part number 40201160).

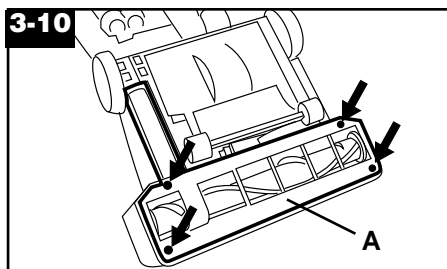

### How to replace

**Disconnect cleaner from electrical outlet.**

#### Remove bottom plate

Place handle in low position and turn cleaner over so bottom side is up.

Remove the 4 screws as shown with a Phillips screwdriver.

Lift off bottom plate (A).

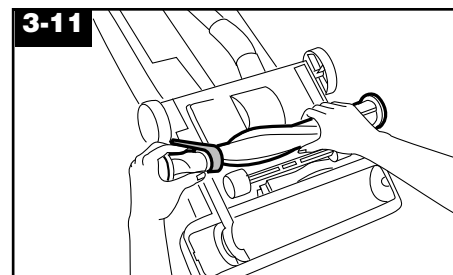

#### Remove agitator brush roll

Remove agitator and used belt.

Discard used belt.

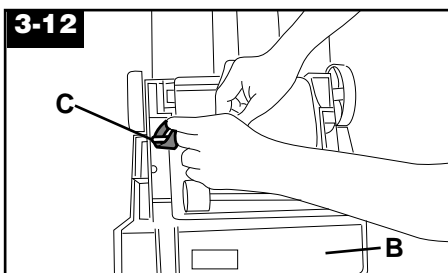

#### Install new belt

With lettering on outside of belt and positioned as shown in box on (B), slide new belt over motor pulley (C).

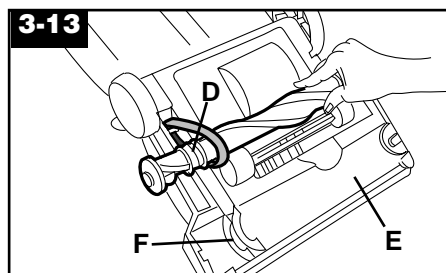

#### Replace agitator brush roll

Insert agitator through belt and place belt in belt guide (D) on agitator.

Should the agitator shield (E) become dislodged while replacing the belt or the agitator, reposition it as shown noting the placement of its belt guide (F).

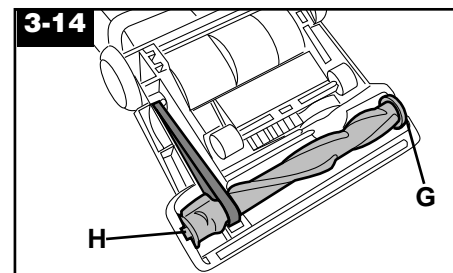

#### Secure agitator

Grasp agitator firmly and fit it into position by first sliding end opposite the belt into the rectangular slot (G) on side of cleaner.

Pull other side of agitator (H) into place. Turn agitator making sure belt is not pinched between agitator and agitator shield.

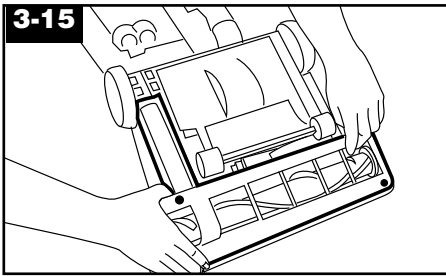

### Replace bottom plate

Reposition bottom plate and 4 Phillips head screws. Tighten screws securely.

## The agitator brush roll When to replace

When agitator brushes are worn, the agitator should be replaced.

To check condition of brushes, **disconnect cleaner from electrical outlet.**

Move edge of a card across bottom plate while turning agitator. To maintain cleaning effectiveness, replace agitator if brushes do not touch card.

### What to buy

Your cleaner requires either a 13" or 15" agitator. When purchasing a new agitator, ask for one of the following:

13" - **HOOVER part No. 48414110**

15" - **HOOVER part No. 48414115.**

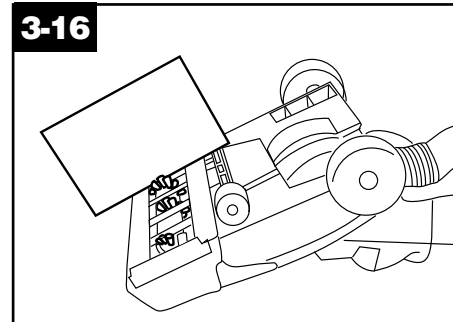

### How to replace

**Disconnect cleaner from electrical outlet.**

Remove bottom plate, belt and agitator following directions in "The belt" section beginning with Fig. 3-10.

Discard old agitator.

Continue following the directions in "The belt" section to reposition belt, new agitator and bottom plate.

## Lubrication

The motor is equipped with bearings that contain sufficient lubrication for the life of the motor. The addition of lubricant could cause damage. **Therefore, do not add lubricant to motor bearings.**

The agitator brush roll is equipped with two ball bearings that should be lubricated periodically by a Hoover Factory Service Center or an Authorized Hoover Warranty Service Dealer (Depot).

## Thermal protector

An internal thermal protector has been designed into your cleaner to protect it from overheating.

**When the thermal protector activates, the cleaner will stop running.** If this happens, proceed as follows:

1. Turn the cleaner OFF and disconnect it from the electrical outlet.
2. Check secondary and final filters for dirt accumulation.
3. Refer to "Clearing blockages" section.
4. **When cleaner is unplugged and the motor cools for 30 minutes,** the thermal protector automatically resets and cleaning may continue. If the thermal protector continues to activate after following the above steps, your cleaner may need servicing (see "Service" section).

## Service

To obtain approved HOOVER service and genuine HOOVER parts, locate the nearest **Hoover Factory Service Center or Authorized Hoover Warranty Service Dealer (Depot)** by:

- checking the Yellow Pages under "Vacuum Cleaners - Household" OR -
- checking the list of Factory Service Centers provided with this cleaner OR -
- checking the Service section of The Hoover Company on-line at **www.hoover.com** OR -
- calling **1-800-944-9200** for an automated referral of authorized service outlet locations (U.S. only).

**Do not** send your cleaner to The Hoover Company in North Canton for service, this will only result in delay.

If further assistance is needed, contact The Hoover Company Consumer Response Center, North Canton, Ohio 44720, Phone: 330-499-9499.

**In Canada,** contact Hoover Canada, Burlington, Ontario L7R 4A8, Phone: 1-800-263-6376.

Always identify your cleaner by the **complete** model number when requesting information or ordering parts. (The model number appears on the bottom of the cleaner.)

## Hoover cleaning performance

This Hoover Cleaning Performance System is for comparing the relative progressive performance of **Hoover uprights only** and not for comparison with any other brands. The majority of this rating is based upon the ASTM International Carpet Cleaning Effectiveness Test (ASTM Test F608). Other performance factors include Hose Power (ASTM Test F558), Surface Litter Cleaning, Hard Floor Cleaning, Edge Cleaning, Cleaning Width, and Air Filtration.

## 4. If you have a problem

If a minor problem occurs, it usually can be solved quite easily when the cause is found by using the check list below.

### Problem: Cleaner won't run

#### Possible cause

#### Possible solution

- **Not firmly plugged in**
  - Plug unit in firmly
- **No voltage in wall plug**
  - Check fuse or breaker
- **Blown fuse or tripped breaker**
  - Replace fuse or reset breaker
- **Thermal protector activated**
  - Allow cleaner to cool for 30 minutes (this will reset the thermal protector).

### Problem: Cleaner/tools won't pick up

#### Possible cause

#### Possible solution

- **Broken or worn belt**
  - Replace belt
- **Agitator brush roll worn**
  - Replace brush roll
- **Filter bag full**
  - Change filter bag
- **Incorrect carpet height setting**
  - Move nozzle control knob to lower setting
- **Blockage in air flow passage**
  - Clear blockage

### Problem: Cleaner hard to push

#### Possible cause

#### Possible solution

- **Incorrect carpet height setting**
  - Move nozzle control knob to a higher setting

### Problem: Smoky/burning smell detected

#### Possible cause

#### Possible solution

- **Belt broken or stretched**
  - Replace agitator brush roll belt as described in Figs. 3-17 through 3-27 in the Maintenance section.

## Clearing blockages

### Disconnect cleaner from electrical outlet.

Low suction or pick up may be due to a blockage in the system. Refer to the following steps to check for blockages **continuing with each step until the blockage is found:**

### Turn cleaner OFF and disconnect from electrical outlet.

1. Check fullness of filter bag; change if needed.

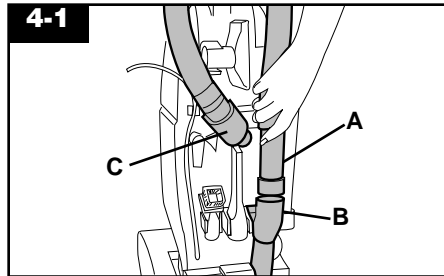

### Check airflow path

2. Plug cleaner in and turn ON. Check for suction at end of hose (A).

a. If there is **suction**, continue with step 3.

b. If there is **no suction**, check for blockage in hose and dirt tube as follows:

- 1) Disconnect hose from dirt duct (C) by reversing procedure for "Attach hose" (Fig. 1-8 and 1-9).
- 2) Clear out hose.
- 3) Look into (C) and remove blockage.

3. Check connection at hose tube (B); remove any blockage.

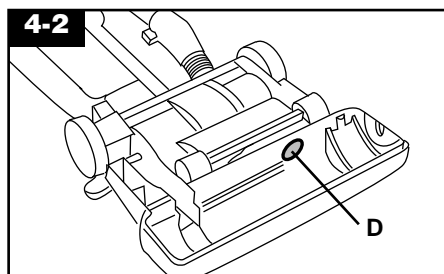

### Checking under bottom plate

4. Turn cleaner OFF and unplug.

5. Remove bottom plate, belt and agitator (see "The belt" section).

Look into opening (D) for blockages and remove.

6. Remove agitator shield (see Fig. 3-13) and remove any loose debris which may have accumulated under it.

## Full One Year Warranty (Domestic Use)

Your HOOVER® appliance is warranted in normal household use, in accordance with the Owner's Manual against original defects in material and workmanship for a period of one full year from date of purchase. This warranty provides, at no cost to you, all labor and parts to place this appliance in correct operating condition during the warranted period. This warranty applies when the appliance is purchased in the United States including its territories and possessions, or in Canada or from a U.S. Military Exchange. Appliances purchased elsewhere are covered by a limited one year warranty which covers the cost of parts only. This warranty does not apply if the appliance is used in a commercial or rental application.

Warranty service can only be obtained by presenting the appliance to one of the following Authorized Warranty Service outlets. Proof of purchase will be required before service is rendered.

1. Hoover Factory Service Centers
2. Hoover Authorized Warranty Service Dealers (Depots)

**For an automated referral of authorized service outlets in the U.S.A., phone 1-800-944-9200 OR**

**visit The Hoover Company on-line at [www.hoover.com](http://www.hoover.com)**

This warranty does not cover pick up, delivery, or house calls; however, if you mail your appliance to a Hoover Factory Service Center for warranty service, transportation will be paid one way.

While this warranty gives you specific legal rights, you may also have other rights which vary from state to state (or province).

If further assistance is needed, or if there are questions concerning this warranty or the availability of warranty service outlets, write or phone the Consumer Response Center, The Hoover Company, 101 East Maple St., North Canton, Ohio 44720. Phone 330-499-9499.

In Canada, contact Hoover Canada, Burlington, Ontario, L7R 4A8. Phone 1-800-263-6376.